

Silicon Carbide Power MOSFET (N-Channel Enhancement)

V_{DS}	650V
I_D (25°C)	65A
$R_{DS(on)}$	30mΩ

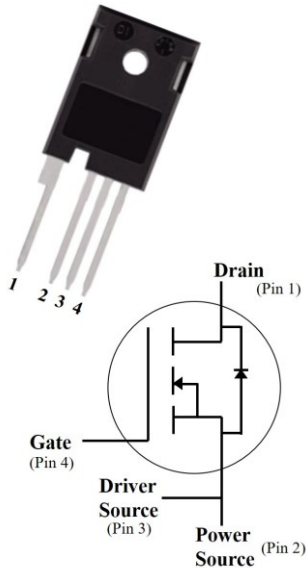

Features

- High speed switching
- Essentially no switching losses
- Reduction of heat sink requirements
- Maximum working temperature at 175 °C
- High blocking voltage
- Fast Intrinsic diode with low recovery current
- High-frequency operation
- Halogen free, RoHS compliant

Typical Applications

Typical applications are in power factor correction(PFC), solar inverter, uninterruptible power supply, motor drives, photovoltaic inverter, electric car and charger.

Mechanical Data

- **Package:** TO247-4L
- **Terminals:** Tin plated leads
- **Polarity:** As marked

■Maximum Ratings ($T_c=25^\circ\text{C}$ Unless otherwise specified)

PARAMETER	SYMBOL	UNIT	VALUE	TEST CONDITIONS	NOTE
Device marking code				D206530NCFG1	
Drain source voltage @ $T_j=25^\circ\text{C}$	$V_{DS,max}$	V	650	$V_{GS}=0\text{ V}$, $I_b=100\mu\text{A}$	
Gate source voltage @ $T_j=25^\circ\text{C}$	$V_{GS,max}$	V	-8/+22	Absolute maximum values	
Gate source voltage @ $T_j=25^\circ\text{C}$	$V_{GS,op}$	V	-4/+18	Recommended operational values	Note1、 2
Continuous drain current @ $T_c=25^\circ\text{C}$	I_D	A	65	$V_{GS}=18\text{V}$, $T_c=25^\circ\text{C}$	Fig.18
Continuous drain current @ $T_c=100^\circ\text{C}$			44	$V_{GS}=18\text{V}$, $T_c=100^\circ\text{C}$	
Pulsed drain current	$I_{D(pulsed)}$	A	220	Pulse width t_p limited by $T_{j,max}$	
Power Dissipation	P_{TOT}	W	260	$T_c=25^\circ\text{C}$, $T_j = 175^\circ\text{C}$	Fig.17
Power Dissipation			108	$T_c=110^\circ\text{C}$, $T_j = 175^\circ\text{C}$	
Operating junction and Storage temperature range	T_j, T_{stg}	$^\circ\text{C}$	-55 to +175		
Soldering temperature	T_L	$^\circ\text{C}$	260	1.6mm (0.063") from case for 10s	
Mounting torque	T_M	Nm	0.6	M3 screw Maximum of mounting process: 3	



■Static Electrical Characteristics (Tc=25°C unless otherwise specified)

PARAMETER	SYMBOL	UNIT	Min.	Typ.	Max.	Test Conditions	Note
Gate threshold voltage	$V_{GS(th)}$	V	1.8	2.4	3.1	$V_{DS}=V_{GS}, I_D=10mA$	Fig.4, 11
				2.0		$V_{DS}=V_{GS}, I_D=10mA, T_j=175^\circ C$	
Drain source breakdown voltage	$V_{(BR)DSS}$	V	650			$V_{GS}=0, I_D=100\mu A$	
Zero gate voltage drain current	I_{DSS}	μA		1	50	$V_{DS}=650V, V_{GS}=0V$	Fig.16
Gate source leakage current	I_{GSS}	nA		10	250	$V_{GS}=22V, V_{DS}=0V$	
Current drain source on-state resistance	$R_{DS(on)}$	m Ω		30	50	$V_{GS}=18V, I_D=25A$	Fig.5, 6, 7
				42		$V_{GS}=18V, I_D=25A, T_j=175^\circ C$	
Internal gate resistance	R_g	Ω		2.5		f=1MHz	
Diode forward voltage	V_{SD}	V		4		$V_{GS}=-4V, I_{SD}=12.5A$	Fig.8
				2.8		$V_{GS}=0V, I_{SD}=12.5A, T_j=175^\circ C$	Fig.9

■Dynamic Electrical Characteristics (Tc=25°C unless otherwise specified)

PARAMETER	SYMBOL	UNIT	Min.	Typ.	Max.	Test Conditions	Note
Input capacitance	C_{iss}	pF		1860		$V_{DS}=400V, V_{GS}=0V, T_j=25^\circ C, f=100kHz, V_{AC}=25mV$	Fig.13, 14
Output capacitance	C_{oss}			185			
Reverse capacitance	C_{rss}			19			
Coss stored energy	E_{oss}	μJ		18			Fig.15
Gate source charge	Q_{gs}	nC		22		$V_{DS}=400V, V_{GS}=-4/18V, I_D=5A$	Fig.12
Gate drain charge	Q_{gd}			38			
Gate charge	Q_g			101			

■Switching Characteristics (Tc=25°C unless otherwise specified)

PARAMETER	SYMBOL	UNIT	Min.	Typ.	Max.	Test Conditions	Note
Turn on switching energy	E_{on}	μJ		120		$V_{DD}=400V, V_{GS}=-4/18V, I_D=25A, R_g=2\Omega, L=100\mu H$	Fig.20, 21
Turn off switching energy	E_{off}			36.5			
Turn on delay time	$t_{d(on)}$	ns		14.6		$V_{DD}=400V, V_{GS}=-4/18V, I_D=25A, R_g=2\Omega, L=100\mu H$	Fig. 22
Rise time	t_r			16.9			
Turn off delay time	$t_{d(off)}$	ns		34.6			
Fall time	t_f			14.6			



■Body diode characteristics (Tc=25°C unless otherwise specified)

PARAMETER	SYMBOL	UNIT	Min.	Typ.	Max.	Test Conditions	Note
Diode forward voltage	V _{SD}	V		4		V _{GS} =-4V, I _{SD} =12.5A	Fig.8
				2.8		V _{GS} =0V, I _{SD} =12.5A T _j =175°C	Fig.9
Continuous diode forward current	I _s	A		45		V _{GS} =-4V, Tc=25°C	Note1
Reverse recovery time	t _{rr}	nS		25		V _R =400V, V _{GS} =-4V, I _D =25A	
Reverse recovery charge	Q _{rr}	nC		100			
Peak reverse recovery current	I _{rrm}	A		5			

Note 1: When using SiC Body Diode the maximum recommended V_{GS} = -4V

Note 2: MOSFET can also safely operate at 0/18 V

■Thermal Characteristics (T_a=25°C Unless otherwise specified)

PARAMETER	SYMBOL	UNIT	Typ.
Thermal resistance	R _{θJ-C}	°C/W	0.48

■Typical Characteristics

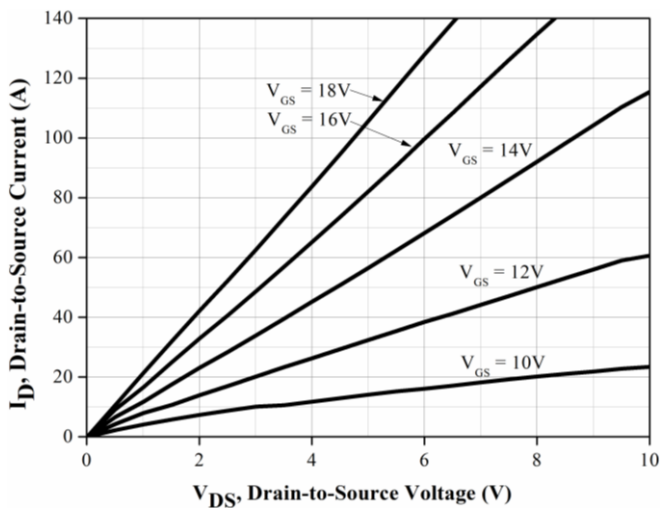

Figure 1. Output Characteristics T_j = -55°C

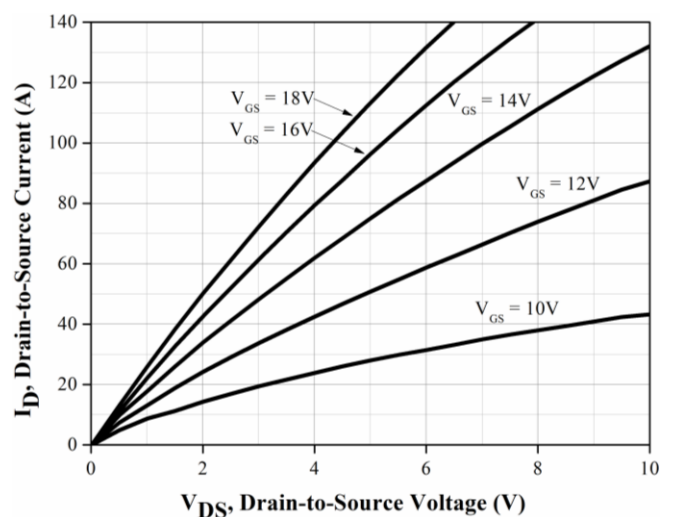

Figure2. Output Characteristics T_j = 25°C

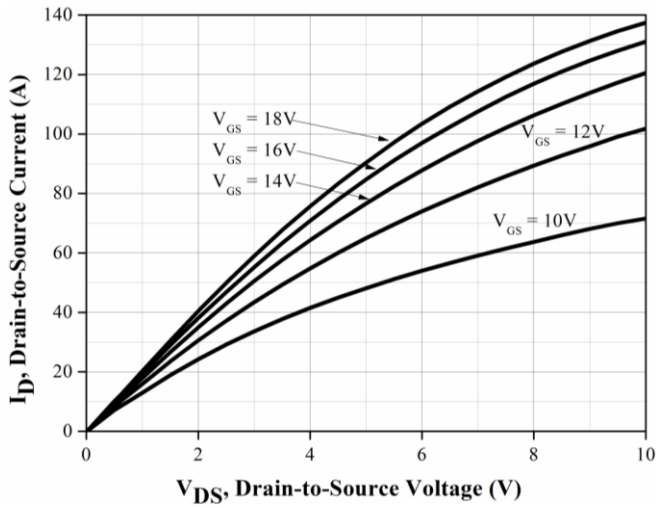

Figure 3. Output Characteristics $T_j = 175^\circ\text{C}$

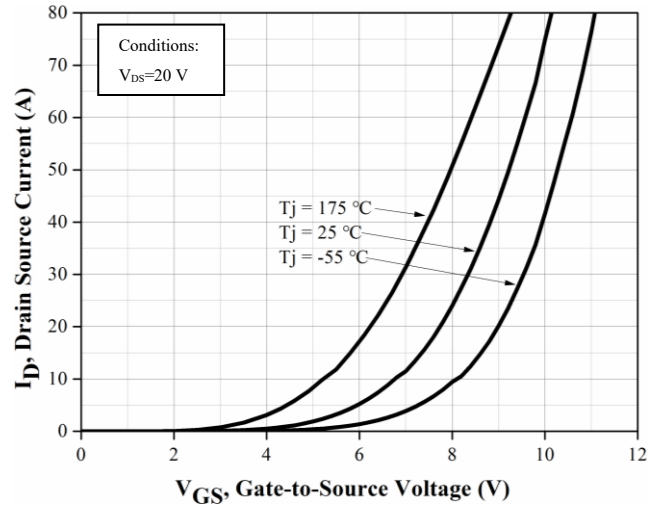

Figure 4. Transfer Characteristics for various junction temperature

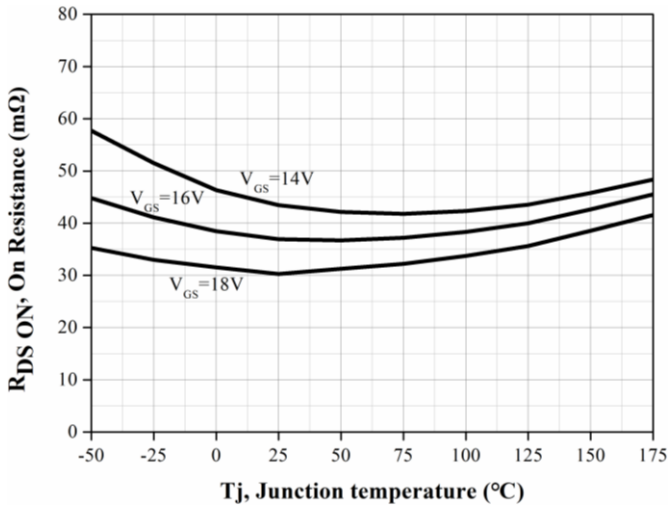

Figure 5. On-resistance vs. temperature for various gate voltage

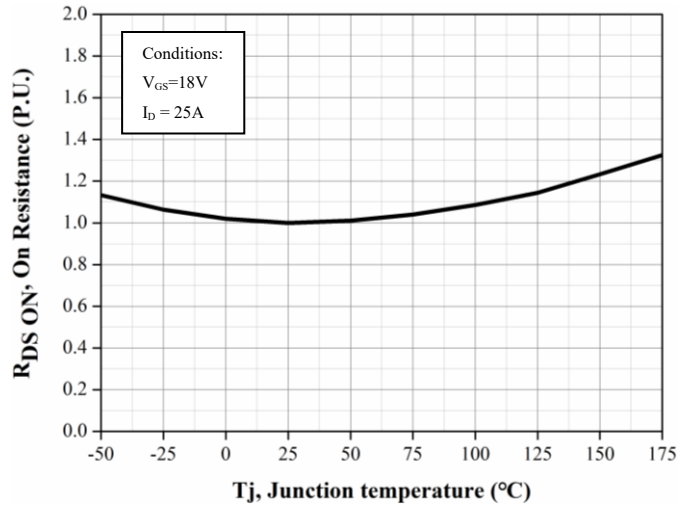

Figure 6. Normalized on-resistance vs. temperature

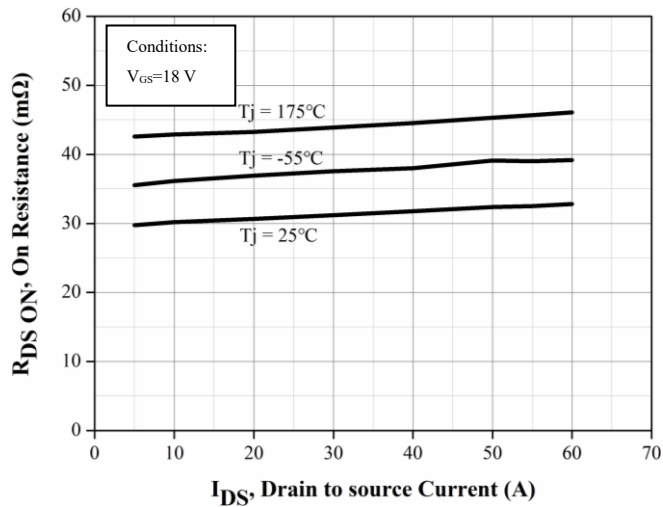

Figure 7. On-resistance vs. drain current

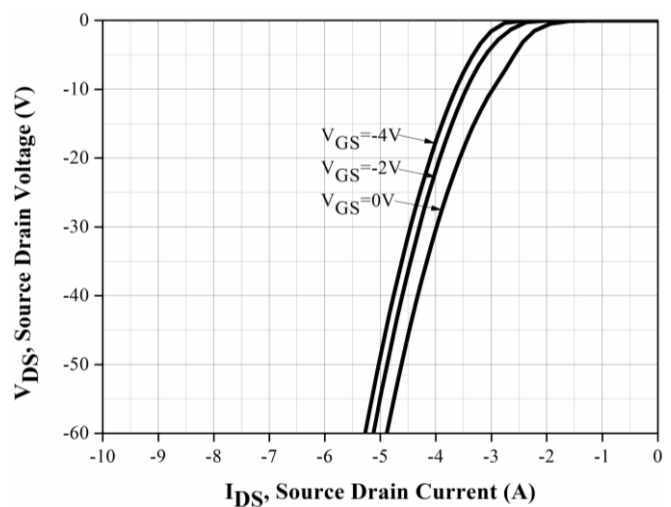

Figure 8. Body diode characteristic at $T_j = 25^\circ\text{C}$

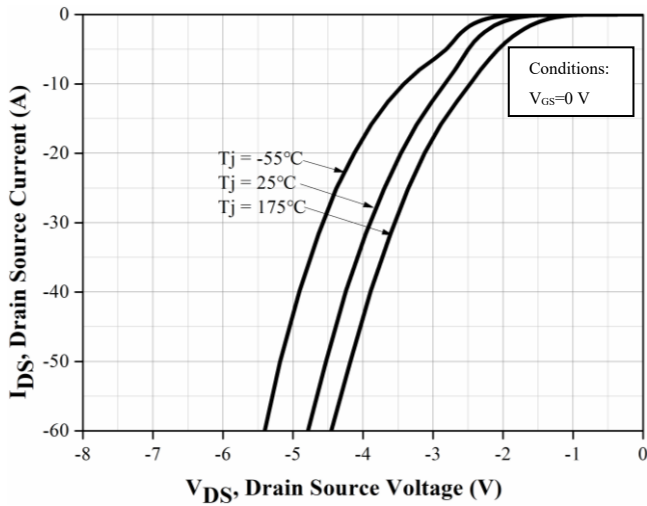

Figure 9. Body diode characteristic

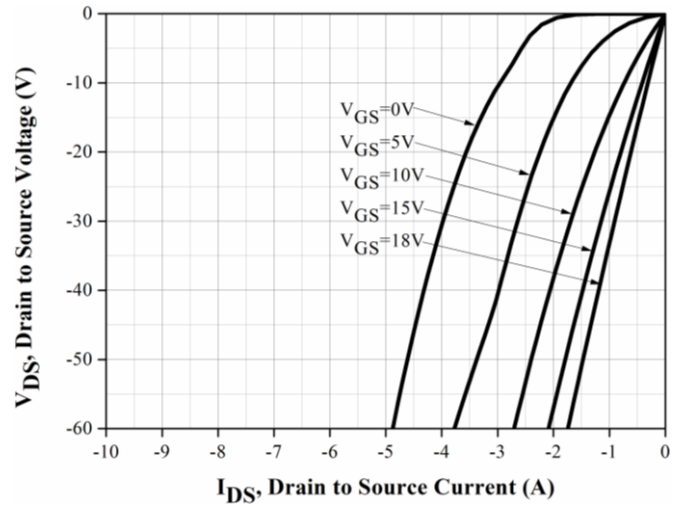

Figure 10. 3rd quadrant characteristic at $T_j = 25^\circ\text{C}$

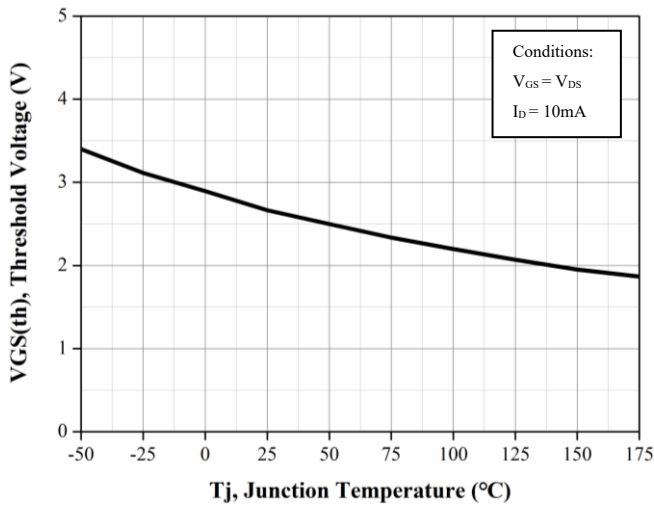

Figure 11. Threshold voltage vs. temperature

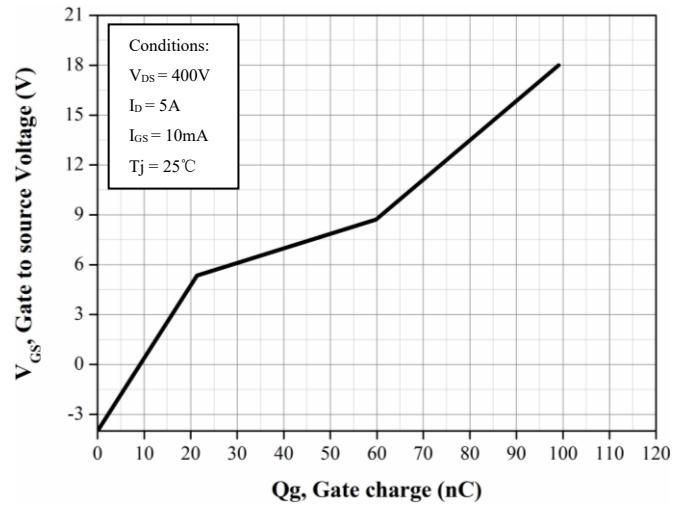

Figure 12. Gate charge characteristic

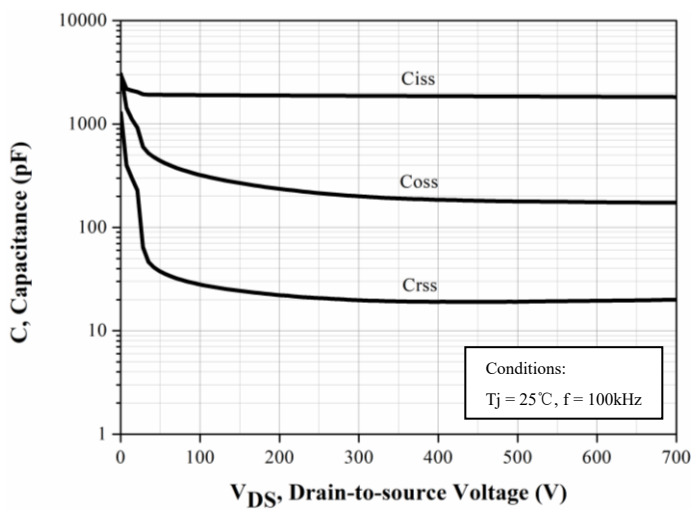

Figure 13. Capacitances vs. drain source voltage (0-700V)

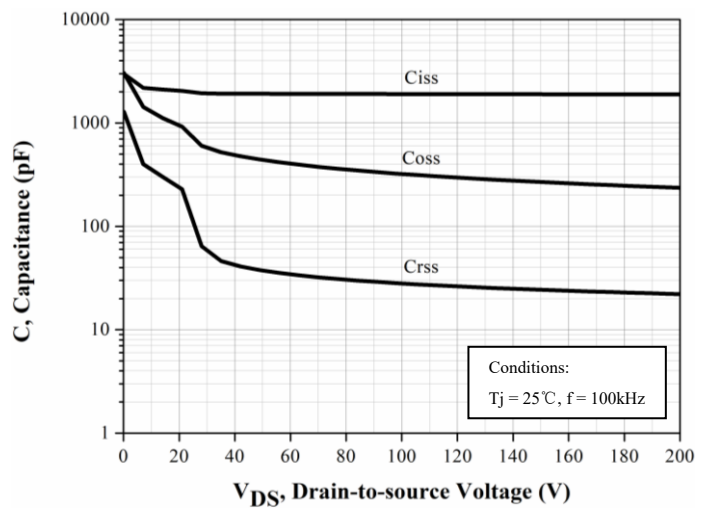

Figure 14. Capacitances vs. drain source voltage (0-200V)

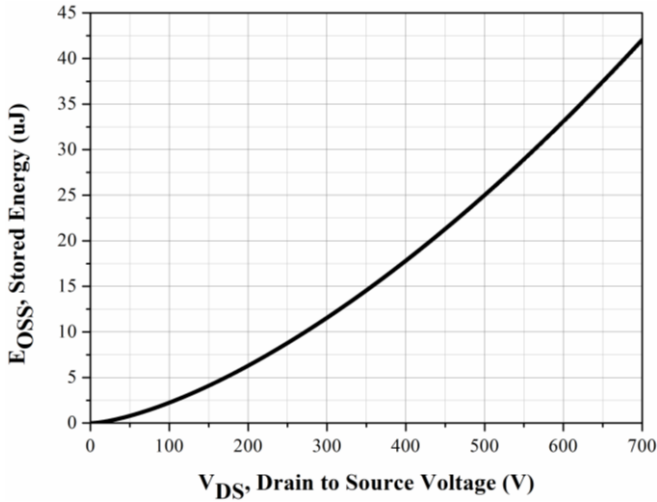

Figure 15. Output capacitor stored energy

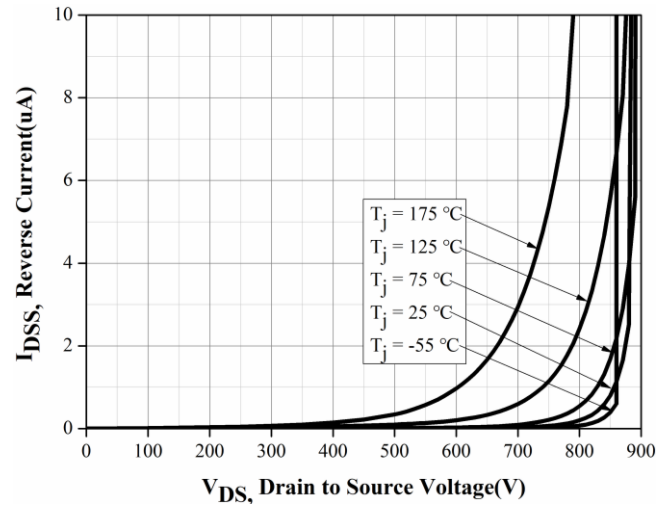

Figure 16. Reverse characteristics vs. T_j

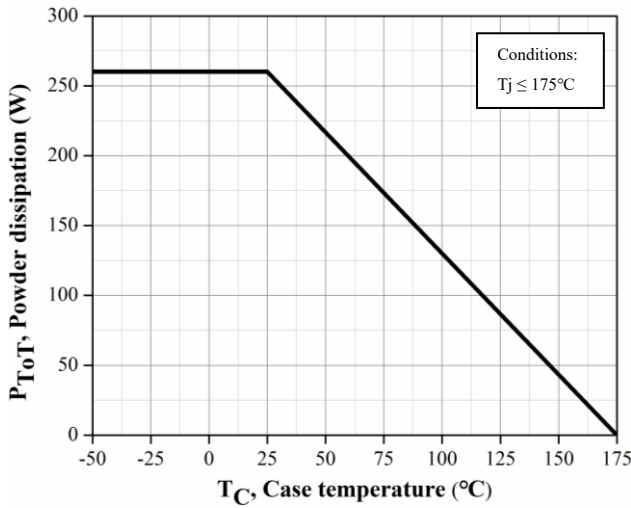

Figure 17. Maximum power dissipation derating vs. case temperature

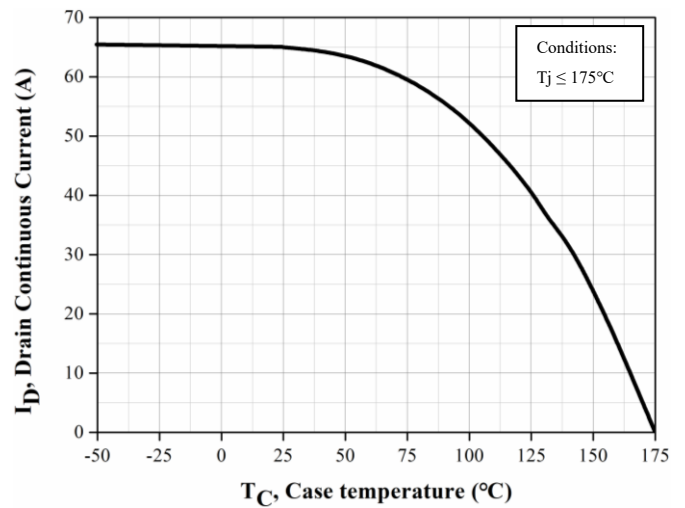

Figure 18. Continuous drain current derating vs. case temperature

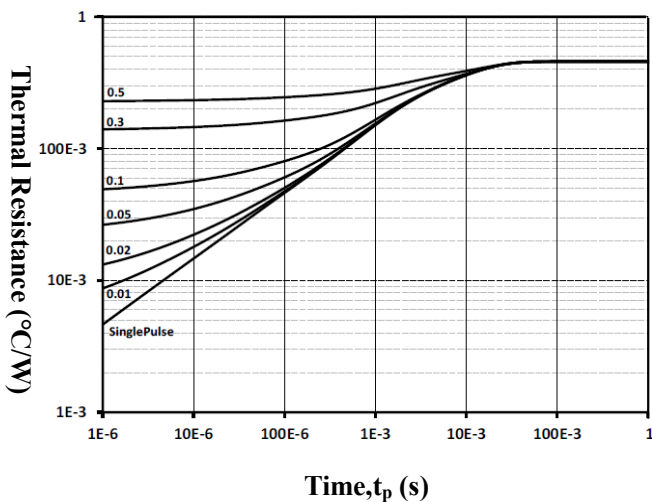

Figure 19. Transient thermal impedance (junction - case)

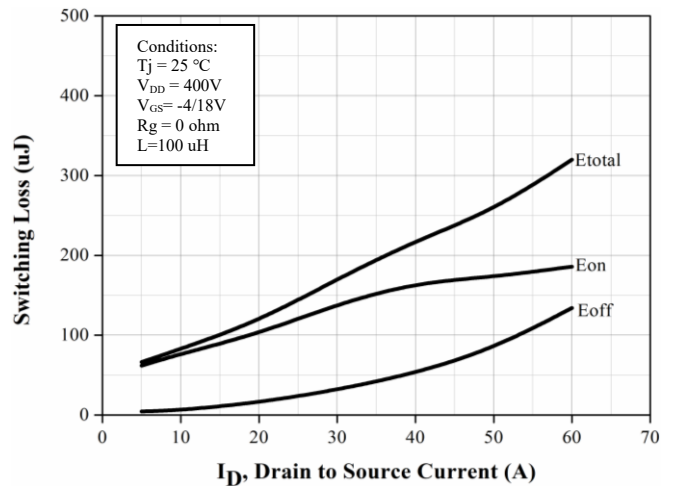

Figure 20. Clamped Inductive switching energy vs. drain current

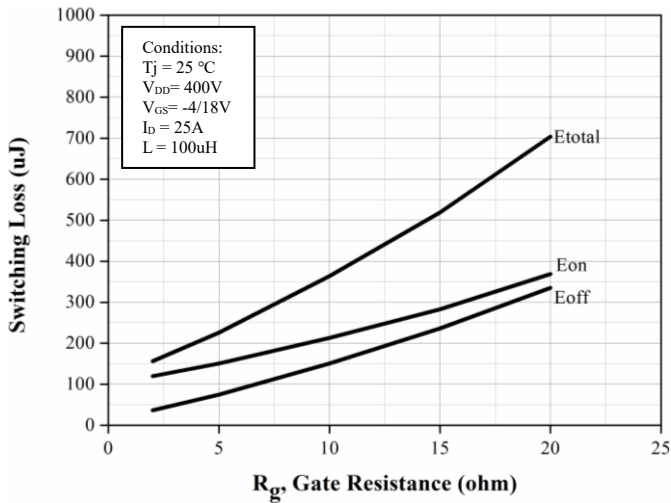

Figure 21. Clamped inductive switching energy vs. Rg

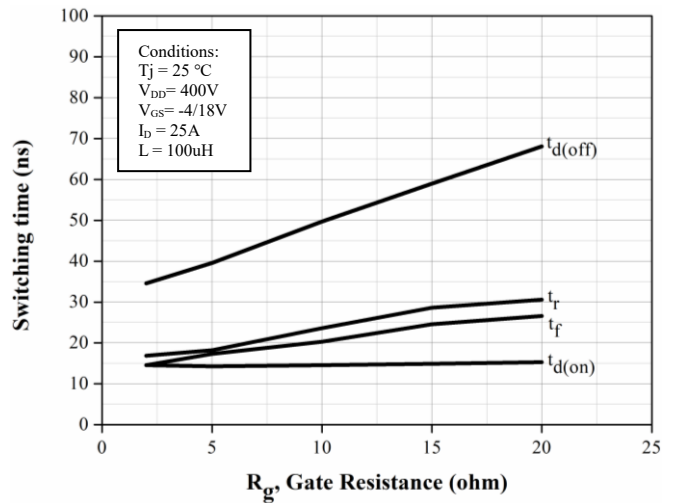

Figure 22. Switching times vs. Rg

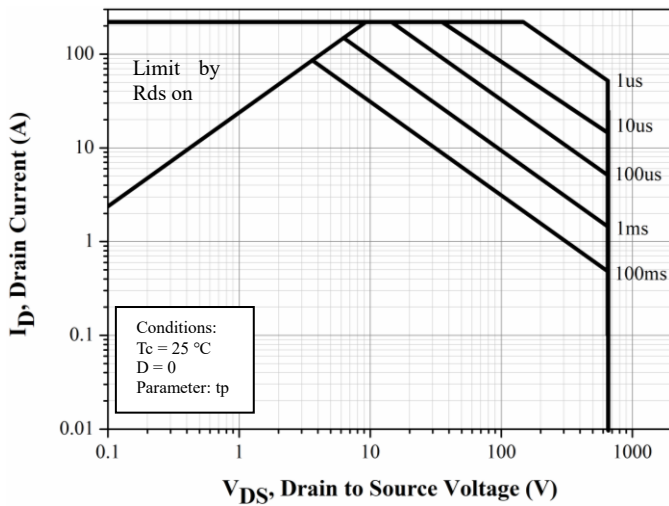

Figure 23. Safe Operating Area

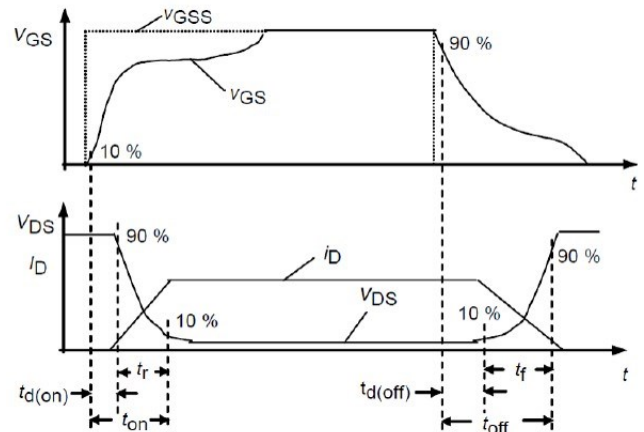

Figure 24. Switching Times Definition

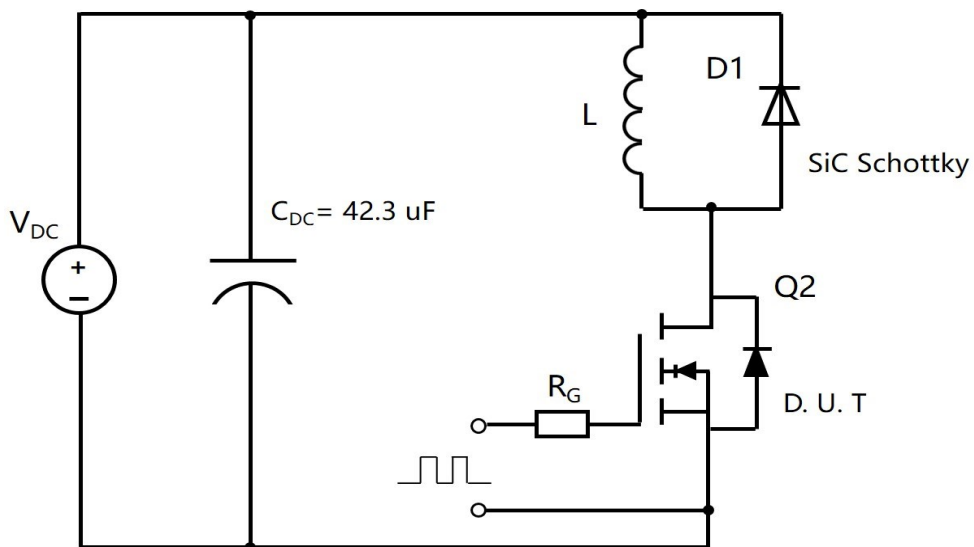
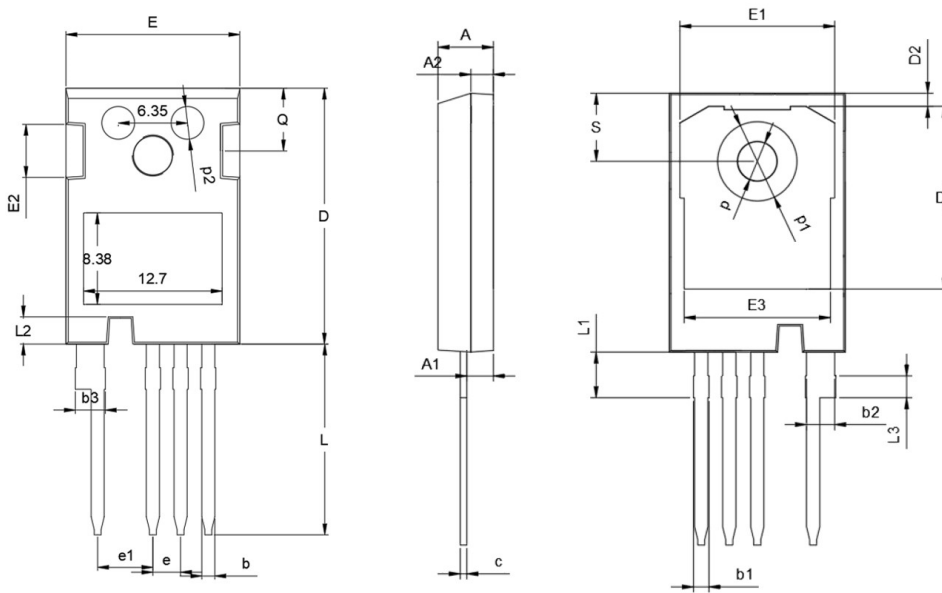

Figure 25. Clamped Inductive Switching Waveform Test Circuit

■Outline Dimensions



TO247-4L			
Dim	Min	Norm	Max
A	4.80	5.00	5.20
A1	2.30	2.40	2.50
A2	1.88	1.98	2.08
b	1.10	1.20	1.30
b1	1.20	/	1.50
b2	2.35	2.55	2.75
b3	2.45	/	2.85
c	0.55	0.60	0.65
D	23.3	23.45	23.6
D1	16.25	16.55	16.85
D2	1.00	/	1.30
e	TYP2.54		
e1	TYP5.06		
E	15.75	15.90	16.05
E1	13.80	/	14.20
E2	4.40	4.75	5.10
E3	13.00	/	13.45
L	17.34	17.49	17.64
L1	4.00	/	4.30
L2	2.35	/	2.65
L3	TYP1.98		
Q	5.60	5.80	6.00
S	6.05	/	6.30
p	TYP3.58		
p1	TYP7.18		
p2	TYP3.00		



Disclaimer

The information presented in this document is for reference only. Yangzhou Yangjie Electronic Technology Co., Ltd. reserves the right to make changes without notice for the specification of the products displayed herein to improve reliability, function or design or otherwise.

The product listed herein is designed to be used with ordinary electronic equipment or devices, and not designed to be used with equipment or devices which require high level of reliability and the malfunction of which would directly endanger human life (such as medical instruments, transportation equipment, aerospace machinery, nuclear-reactor controllers, fuel controllers and other safety devices), Yangjie or anyone on its behalf, assumes no responsibility or liability for any damages resulting from such improper use of sale.

This publication supersedes & replaces all information previously supplied. For additional information, please visit our website [http:// www.21yangjie.com](http://www.21yangjie.com) , or consult your nearest Yangjie's sales office for further assistance.