

## P-Channel Enhancement Mode Field Effect Transistor

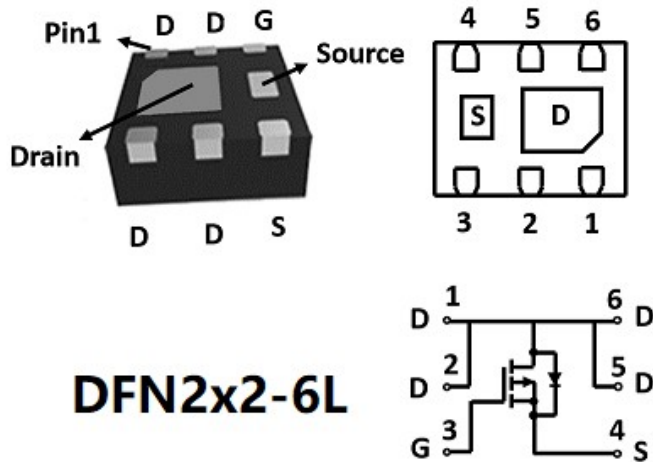

### Product Summary

- $V_{DS}$  -20V
- $I_D$  -16A
- $R_{DS(ON)}$ ( at  $V_{GS} = -4.5V$ ) <19mohm
- $R_{DS(ON)}$ ( at  $V_{GS} = -2.5V$ ) <22mohm
- $R_{DS(ON)}$ ( at  $V_{GS} = -1.8V$ ) <30mohm

### General Description

- Trench Power MV MOSFET technology
- High density cell design for Low  $R_{DS(ON)}$
- High Speed switching

### Applications

- Battery protection
- Load switch
- Power management

### ■ Absolute Maximum Ratings ( $T_A=25^\circ C$ unless otherwise noted)

Parameter	Symbol	Maximum	Unit
Drain-source Voltage	$V_{DS}$	-20	V
Gate-source Voltage	$V_{GS}$	$\pm 10$	V
Drain Current	$I_D$	$T_C=25^\circ C$ @ Steady State	-16
		$T_C=70^\circ C$ @ Steady State	-12.8
Pulsed Drain Current <sup>A</sup>	$I_{DM}$	-64	A
Total Power Dissipation @ $T_C=25^\circ C$	$P_D$	18	W
Thermal Resistance Junction-to-Case @ Steady State	$R_{\theta JC}$	6.9	$^\circ C/W$
Junction and Storage Temperature Range	$T_J, T_{STG}$	-55~+150	$^\circ C$

### ■ Ordering Information (Example)

PREFERRED P/N	PACKING CODE	Marking	MINIMUM PACKAGE(pcs)	INNER BOX QUANTITY(pcs)	OUTER CARTON QUANTITY(pcs)	DELIVERY MODE
YJQ1216A	F1	Q1216	3000	30000	120000	7" reel



# YJQ1216A

## ■ Electrical Characteristics (T<sub>J</sub>=25°C unless otherwise noted)

Parameter	Symbol	Conditions	Min	Typ	Max	Units
<b>Static Parameter</b>						
Drain-Source Breakdown Voltage	BV <sub>DSS</sub>	V <sub>GS</sub> =0V, I <sub>D</sub> =-250μA	-20			V
Zero Gate Voltage Drain Current	I <sub>DSS</sub>	V <sub>DS</sub> =-20V, V <sub>GS</sub> =0V, T <sub>C</sub> =25°C			-1	μA
Gate-Body Leakage Current	I <sub>GSS</sub>	V <sub>GS</sub> = ±10V, V <sub>DS</sub> =0V			±100	nA
Gate Threshold Voltage	V <sub>GS(th)</sub>	V <sub>DS</sub> = V <sub>GS</sub> , I <sub>D</sub> =-250μA	-0.4	-0.62	-1.0	V
Static Drain-Source On-Resistance	R <sub>DS(on)</sub>	V <sub>GS</sub> = -4.5V, I <sub>D</sub> =-10A		11	19	mΩ
		V <sub>GS</sub> = -2.5V, I <sub>D</sub> =-6.5A		14	22	
		V <sub>GS</sub> = -1.8V, I <sub>D</sub> =-4.0A		20	30	
Diode Forward Voltage	V <sub>SD</sub>	I <sub>S</sub> =-13A, V <sub>GS</sub> =0V		-0.8	-1.2	V
Maximum Body-Diode Continuous Current	I <sub>S</sub>				-13	A
<b>Dynamic Parameters</b>						
Input Capacitance	C <sub>iss</sub>	V <sub>DS</sub> =-10V, V <sub>GS</sub> =0V, f=1MHZ		2992		pF
Output Capacitance	C <sub>oss</sub>			330		
Reverse Transfer Capacitance	C <sub>rss</sub>			272		
<b>Switching Parameters</b>						
Total Gate Charge	Q <sub>g</sub>	V <sub>GS</sub> =-10V, V <sub>DS</sub> =-15V, I <sub>D</sub> =-9.1A		72.8		nC
Gate Source Charge	Q <sub>gs</sub>			6.6		
Gate Drain Charge	Q <sub>gd</sub>			10.1		
Reverse Recovery Charge	Q <sub>rr</sub>	I <sub>F</sub> =-6A, di/dt=100A/us		34		
Reverse Recovery Time	t <sub>rr</sub>			67		
Turn-on Delay Time	t <sub>D(on)</sub>	V <sub>GS</sub> =-10V, V <sub>DS</sub> =-15V, I <sub>D</sub> =-6A, R <sub>GEN</sub> =2.5Ω		7		ns
Turn-on Rise Time	t <sub>r</sub>			33		
Turn-off Delay Time	t <sub>D(off)</sub>			130		
Turn-off Fall Time	t <sub>f</sub>			132		

A. Pulse Test: Pulse Width ≤ 300us, Duty cycle ≤ 2%.

B. R<sub>θJA</sub> is the sum of the junction-to-case and case-to-ambient thermal resistance, where the case thermal reference is defined as the solder mounting surface of the drain pins. R<sub>θJC</sub> is guaranteed by design, while R<sub>θJA</sub> is determined by the board design. The maximum rating presented here is based on mounting on a 1 in 2 pad of 2oz copper.



■ Typical Performance Characteristics

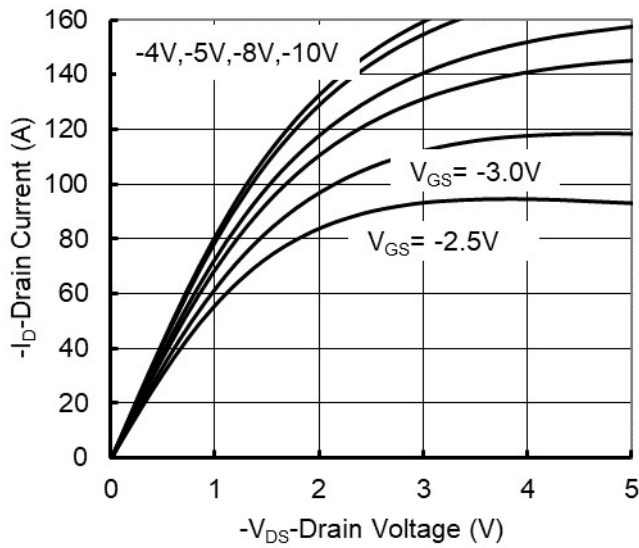

Figure 1. Output Characteristics

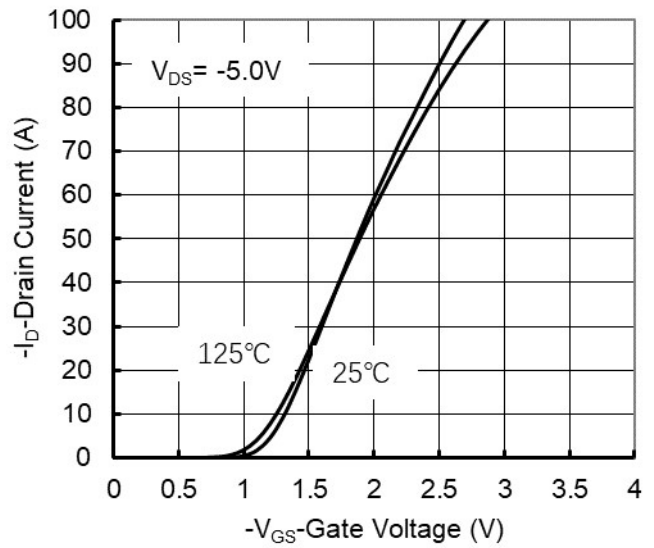

Figure 2. Transfer Characteristics

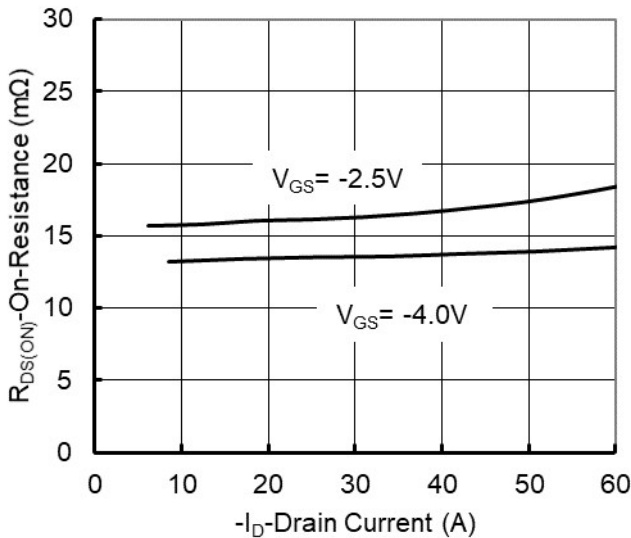

Figure 3. On-Resistance vs. Drain Current and Gate Voltage

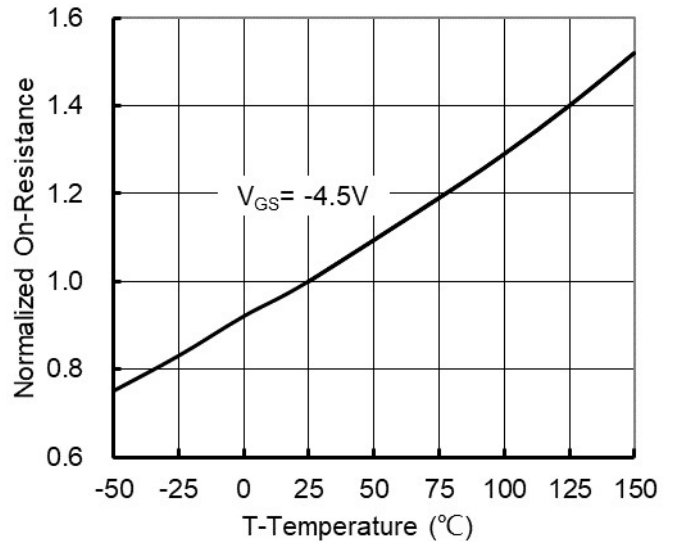

Figure 4. On-Resistance vs. Junction Temperature

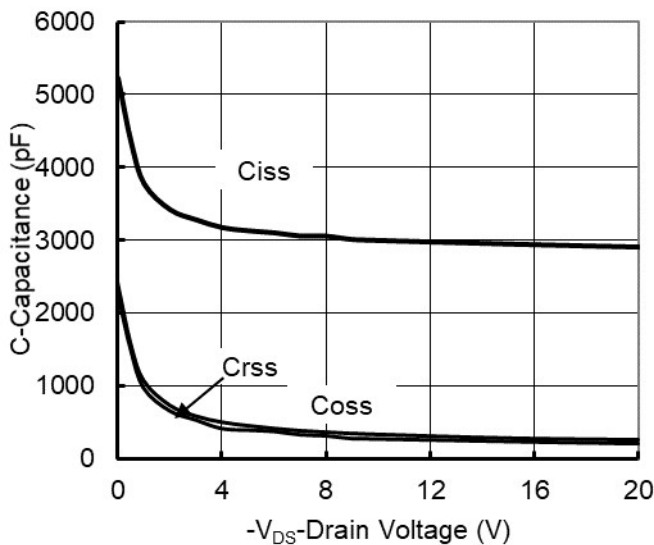

Figure 5. Capacitance Characteristics

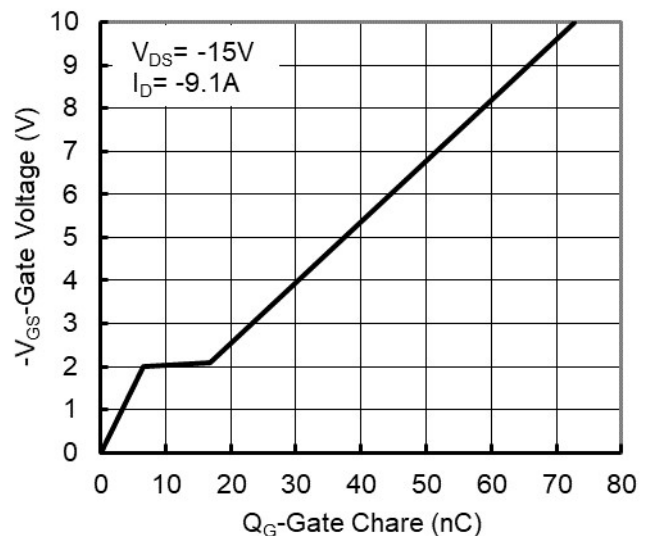

Figure 6. Gate Charge

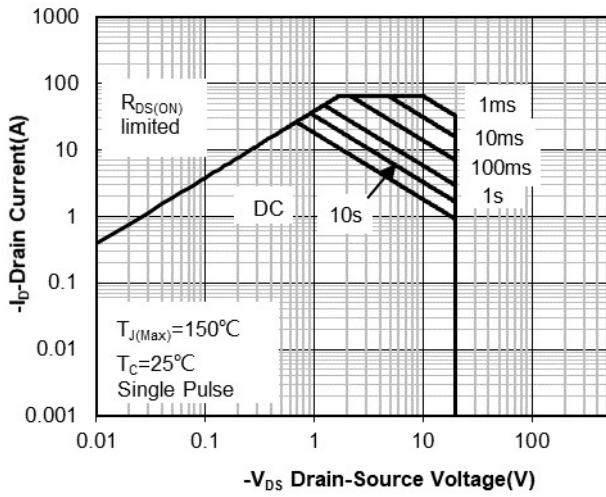

Figure 7. Safe Operation Area

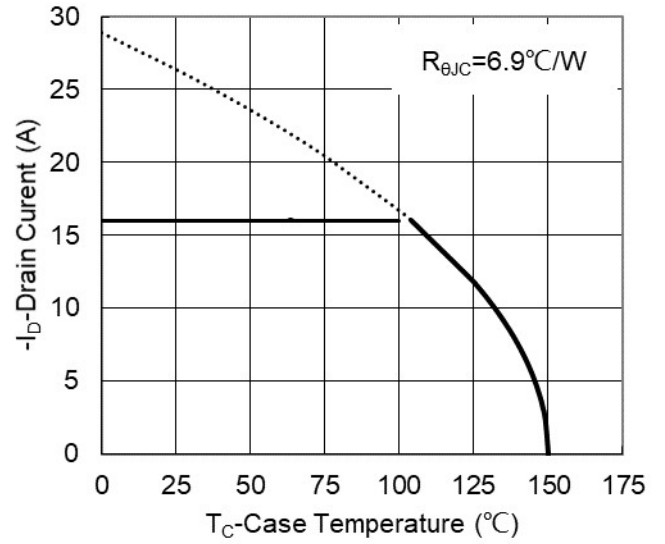
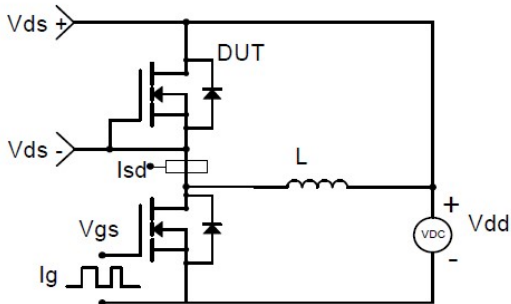

Figure 8. Maximum Continuous Drain Current vs Case Temperature



**Resistive Switching Test Circuit & Waveforms**



**Diode Recovery Test Circuit & Waveforms**

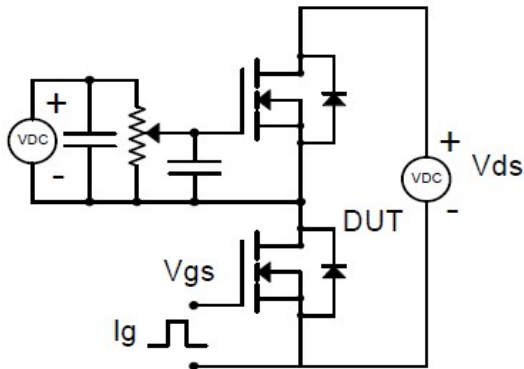

**Gate Charge Test Circuit & Waveform**

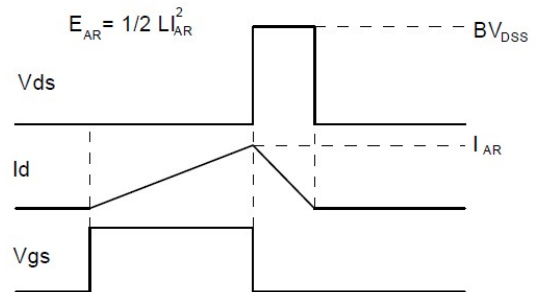

**Unclamped Inductive Switching (UIS) Test Circuit & Waveforms**



# YJQ1216A

## ■DFN2x2-6L(0.80mm) Package information

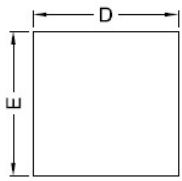

Top View  
正面视图

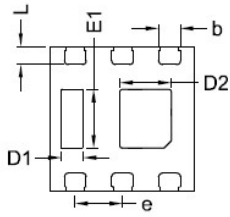

Bottom View  
背面视图

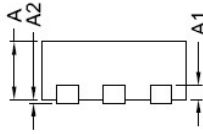

Side View  
侧面视图

SYMBOL	MILLIMETER		
	MIN	NOM	MAX
D	1.90	2.00	2.10
E	1.90	2.00	2.10
A	0.70	0.80	0.90
A1	0.20 BSC		
A2			0.10
D1	0.20	0.30	0.40
D2	0.61	0.71	0.81
E1	0.71	0.81	0.91
L	0.15	0.25	0.35
b	0.20	0.30	0.40
e	0.65 BSC		

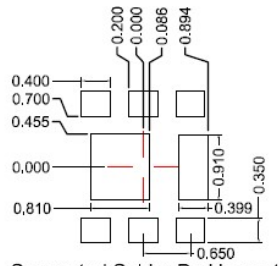

Suggested Solder Pad Layout  
Top View

Note:

1. Controlling dimension: in millimeters.
2. General tolerance:  $\pm 0.10$ mm.
3. The pad layout is for reference purposes only.



# YJQ1216A

---

## Disclaimer

The information presented in this document is for reference only. Yangzhou Yangjie Electronic Technology Co., Ltd. reserves the right to make changes without notice for the specification of the products displayed herein to improve reliability, function or design or otherwise.

The product listed herein is designed to be used with ordinary electronic equipment or devices, and not designed to be used with equipment or devices which require high level of reliability and the malfunction of which would directly endanger human life (such as medical instruments, transportation equipment, aerospace machinery, nuclear-reactor controllers, fuel controllers and other safety devices), Yangjie or anyone on its behalf, assumes no responsibility or liability for any damages resulting from such improper use of sale.

This publication supersedes & replaces all information previously supplied. For additional information, please visit our website [http:// www.21yangjie.com](http://www.21yangjie.com) , or consult your nearest Yangjie's sales office for further assistance.