

Ultra-Small, Low-Input Voltage, Low R_{ON} Load Switch

Description

JXW1512 device is low R_{ON} MOSEFT controlled by external logic pin, allowing optimization of battery life, and portable device autonomy. It includes a P-channel MOSFET that operates over an input voltage range of 1.2V to 5.5V. An on/off input (ON) controls the switch that can interface with low voltage control signals. A 130 Ω on chip load resistor is added for output quick discharge when the switch is turned off. JXW1512 is packaged in WLCSP-4 with 0.4mm pitch. It is characterized for operation over the free-air tem-perature range of -40°C to 85°C.

Applications

- Cellular Phones
- GPS Devices
- Digital Cameras
- Peripheral Ports
- Portable Instrumentation
- RF Modules
- Personal Digital Assistants (PDAs)
- MP3 Players

Features

- Low-Input Voltage: 1.2V to 5.5V
- Ultra-Low ON-State Resistance
 - ◆ $R_{ON}=48m\Omega$ at $V_{IN}=5.0V$
 - ◆ $R_{ON}=53m\Omega$ at $V_{IN}=4.2V$
 - ◆ $R_{ON}=56m\Omega$ at $V_{IN}=3.6V$
 - ◆ $R_{ON}=67m\Omega$ at $V_{IN}=2.5V$
 - ◆ $R_{ON}=87m\Omega$ at $V_{IN}=1.8V$
 - ◆ $R_{ON}=160m\Omega$ at $V_{IN}=1.2V$
- DC Current Up to 1.5A
- Ultra-Low Quiescent Current: 80nA at 1.8V
- Ultra-Low Shutdown Current: 7.5nA at 1.8V
- Low Control Input Thresholds Enable Use of 1.2V/1.8V/3.6V/4.2V/5.0V Logic
- Controlled Slew Rate to Avoid Inrush Current
- Reverse Current Protection
- Package: WLCSP-4 (0.4mm Pitch)

Typical Application

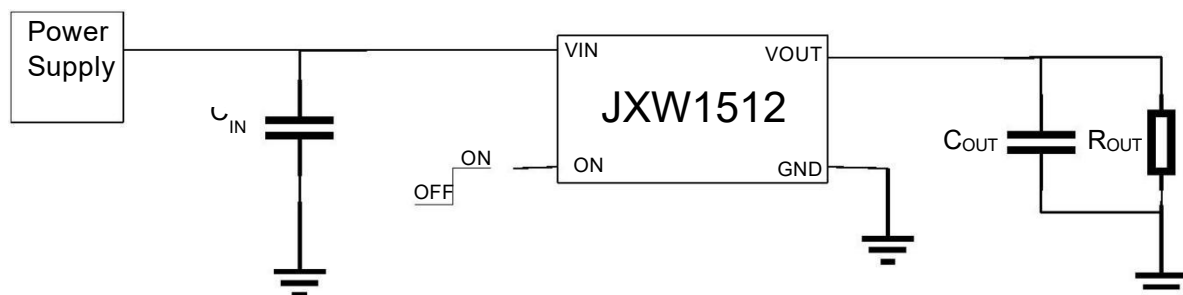

Package and Order Information

Model	Order Number	Package Description	Temperature Range	Packaging Option	Marking Information
JXW1512	JXW1512ACST	WLCSP-4	-40°C ~ 125°C	3000/Tape & Reel	XXT
	JXW1512ACPT				XXT

Pin Configuration and Top Mark

(Top View)

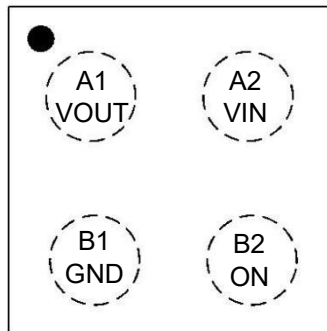

WLCSP-0.8x0.8-4B

Pin Assignments

Name	NO.	Description
VOUT	A1	Switch output
VIN	A2	Switch input, a bypass capacitor should be connected to ground together with it
GND	B1	Ground
ON	B2	Switch control input, active high



Absolute Maximum Ratings ($T_A = 25^\circ\text{C}$ unless otherwise specified)

Symbol	Parameter	Rating	Unit
V_{IN}	Input voltage	-0.3 to 6	V
V_{OUT}	Output voltage	$V_{IN} + 0.3$	V
V_{ON}	Input voltage	-0.3 to 6	V
P_D	Power dissipation at $T_A=25^\circ\text{C}$	0.48	W
I_{MAX}	Maximum continuous switch current	2	A
T_A	Operating free air temperature range	-40 to 85	$^\circ\text{C}$
T_{LEAD}	Maximum lead temperature (10s soldering time)	300	$^\circ\text{C}$
T_{STG}	Storage temperature	-45 to 145	$^\circ\text{C}$
θ_{JA}	Thermal Resistance	190	$^\circ\text{C/W}$
ESD	HBM: All Pins	± 4000	V
	CDM	± 1000	
Latch up		± 200	mA

Recommend Operating Conditions

Symbol	Parameter	Rating	Unit
V_{IN}	Input voltage range	1.2 to 5.5	V
V_{OUT}	Output voltage range	V_{IN}	V
C_{IN}	Input capacitor	1	μF



Electrical Characteristics (T_A = 25°C unless otherwise specified)

Symbol	Parameter	Conditions	Min.	Typ.	Max.	Unit	
I _Q	Quiescent current	I _{OUT} =0, V _{IN} =V _{ON}	V _{IN} =1.2V	40	75	130	nA
			V _{IN} =1.8V		80		
			V _{IN} =3.6V	90	119	250	
			V _{IN} =4.2V		142		
			V _{IN} =5.0V	150	188	350	
I _{SD}	OFF-state supply current	V _{ON} =GND, V _{OUT} =Open	V _{IN} =1.2V		7	20	nA
			V _{IN} =1.8V		7.5		
			V _{IN} =3.6V		10	30	
			V _{IN} =4.2V		12		
			V _{IN} =5.0V		20	50	
I _{LKG}	OFF-state switch current	V _{ON} =GND, V _{OUT} =0	V _{IN} =1.2V		7.5		nA
			V _{IN} =1.8V		8		
			V _{IN} =3.6V		10		
			V _{IN} =4.2V		12.5		
			V _{IN} =5.0V		20.5		
R _{ON}	ON-state resistance	I _{OUT} =-200mA	V _{IN} =1.2V	140	160	190	mΩ
			V _{IN} =1.8V		87		
			V _{IN} =2.5V		68		
			V _{IN} =3.6V		56		
			V _{IN} =4.2V		53		
			V _{IN} =5.0V	30	48	70	
R _{ON_PD}	ON pull down resistance			100		MΩ	
R _{PD}	Output pull down resistance	V _{IN} =3.3V, V _{ON} =0		130	150	Ω	
V _{IH}	High level input voltage	V _{IN} =1.2V to 5.5V	1.0			V	
V _{IL}	Low level input voltage	V _{IN} =1.2V to 5.5V			0.5	V	



JXW1512

Switching Characteristics (T_A = 25°C unless otherwise specified)

Symbol	Parameter	Conditions		Min.	Typ.	Max.	Unit
V _{IN} =1.2V							
t _{ON}	Turn on time	R _L =500Ω	C _L =0.1μF		370		μs
t _{OFF}	Turn off time	R _L =500Ω	C _L =0.1μF		10		us
t _R	VOUT rise time	R _L =500Ω	C _L =0.1μF		29		μs
t _F	VOUT fall time	R _L =500Ω	C _L =0.1μF		26		μs
V _{IN} =1.8V							
t _{ON}	Turn on time	R _L =500Ω	C _L =0.1μF		145		μs
t _{OFF}	Turn off time	R _L =500Ω	C _L =0.1μF		13		us
t _R	VOUT rise time	R _L =500Ω	C _L =0.1μF		46		μs
t _F	VOUT fall time	R _L =500Ω	C _L =0.1μF		27		μs
V _{IN} =3.6V							
t _{ON}	Turn on time	R _L =500Ω	C _L =0.1μF		117		μs
t _{OFF}	Turn off time	R _L =500Ω	C _L =0.1μF		14		us
t _R	VOUT rise time	R _L =500Ω	C _L =0.1μF		110		μs
t _F	VOUT fall time	R _L =500Ω	C _L =0.1μF		26		μs
V _{IN} =4.2V							
t _{ON}	Turn on time	R _L =500Ω	C _L =0.1μF		119		μs
t _{OFF}	Turn off time	R _L =500Ω	C _L =0.1μF		14		us
t _R	VOUT rise time	R _L =500Ω	C _L =0.1μF		130		μs
t _F	VOUT fall time	R _L =500Ω	C _L =0.1μF		26		μs
V _{IN} =5V							
t _{ON}	Turn on time	R _L =500Ω	C _L =0.1μF		119		μs
t _{OFF}	Turn off time	R _L =500Ω	C _L =0.1μF		14		us
t _R	VOUT rise time	R _L =500Ω	C _L =0.1μF		140		μs
t _F	VOUT fall time	R _L =500Ω	C _L =0.1μF		25		μs



JXW1512

Typical Performance Characteristics ($C_{IN} = 1\mu F$, $C_{OUT} = 0.1\mu F$, $R_{OUT} = 10\Omega$, $T_A = 25^\circ C$ unless otherwise specified)

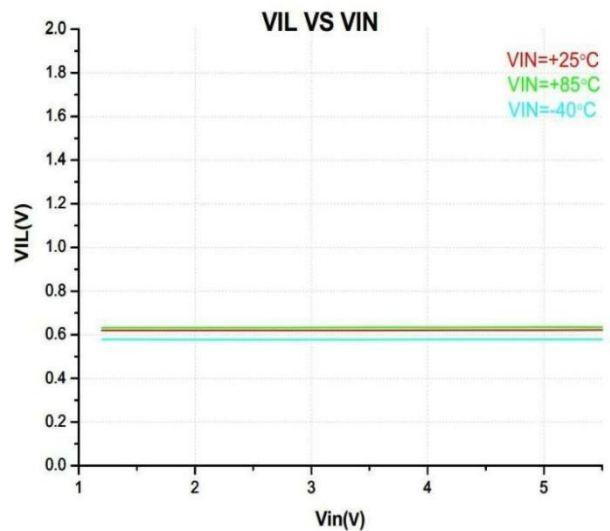
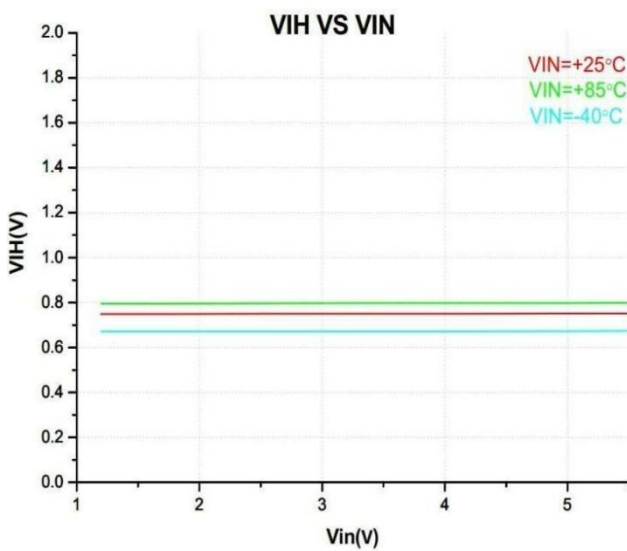
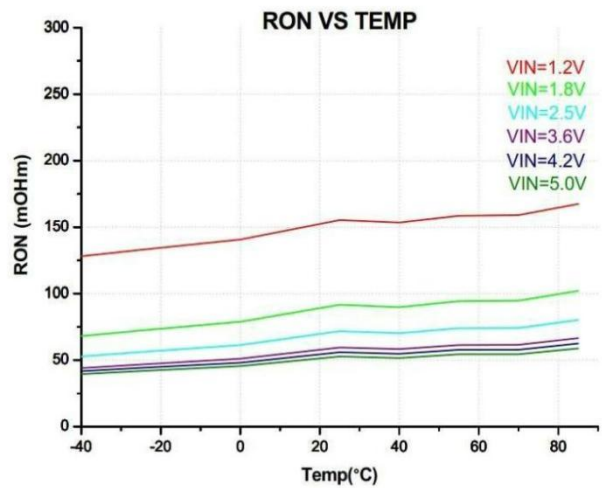
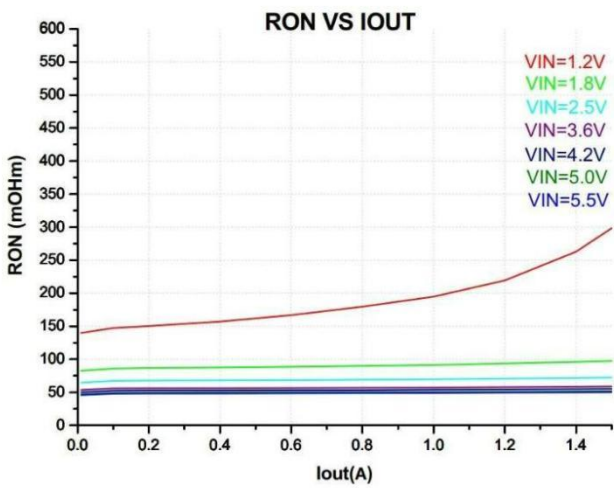
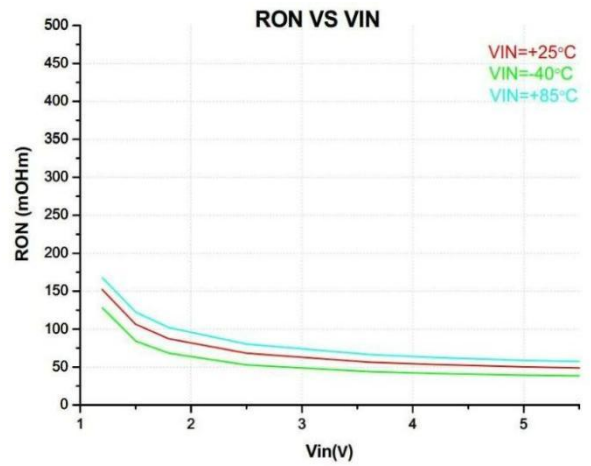
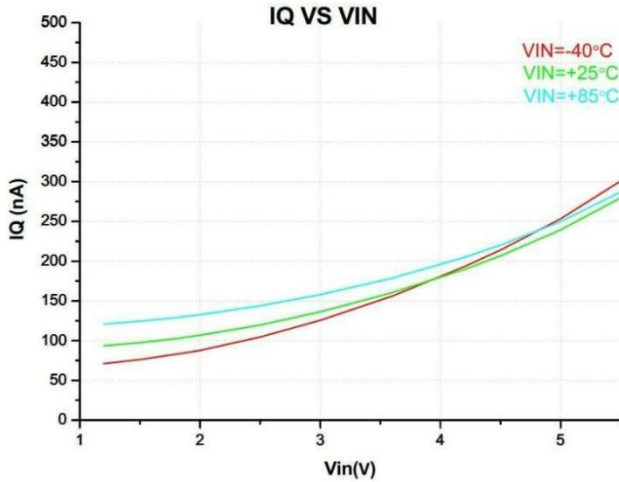



JXW1512

Typical Performance Characteristics ($C_{IN} = 1\mu F$, $C_{OUT} = 0.1\mu F$, $R_{OUT} = 10\Omega$, $T_A = 25^\circ C$ unless otherwise specified)

V_{ON} ON Response w/o load

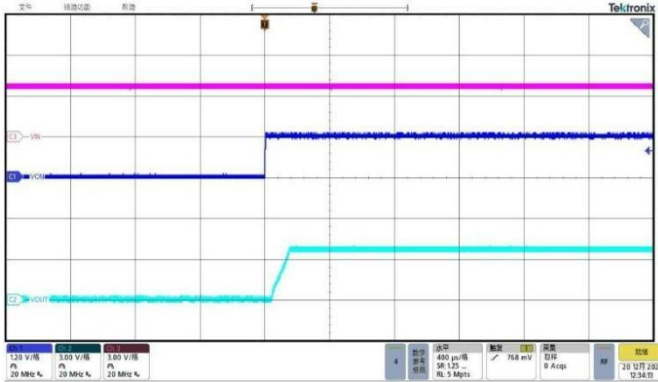

$V_{IN}=3.7V$, $V_{ON}=1.2V$

V_{ON} OFF Response w/o load

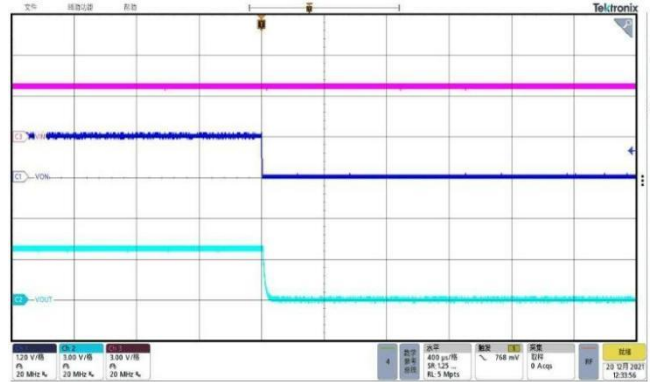

$V_{IN}=3.7V$, $V_{ON}=1.2V$

V_{ON} ON Response with 10Ω load

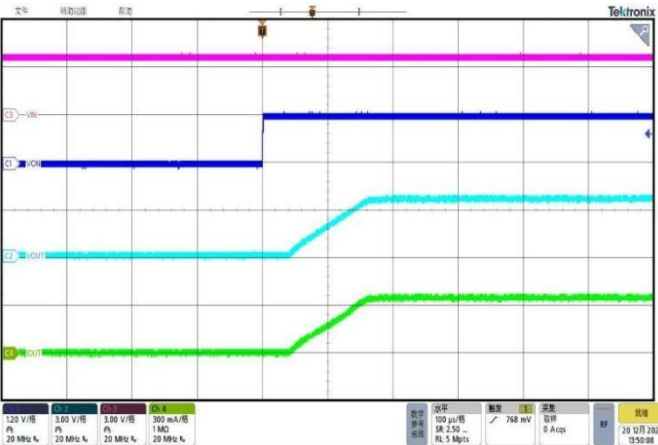

$V_{IN}=3.7V$, $V_{ON}=1.2V$

V_{ON} OFF Response with 10Ω load

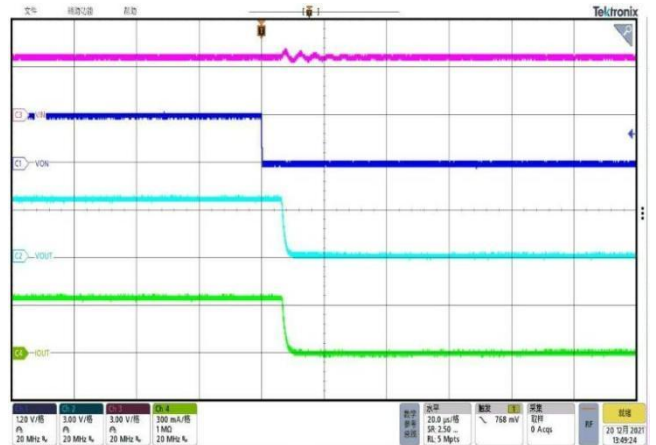

$V_{IN}=3.7V$, $V_{ON}=1.2V$

V_{ON} ON Response w/o load

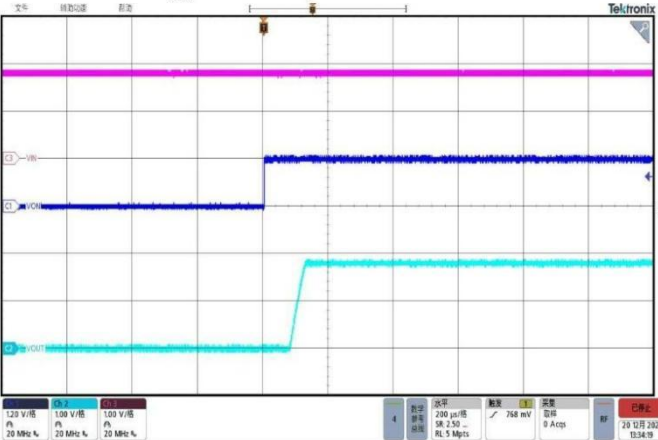

$V_{IN}=1.8V$, $V_{ON}=1.2V$

V_{ON} OFF Response w/o load

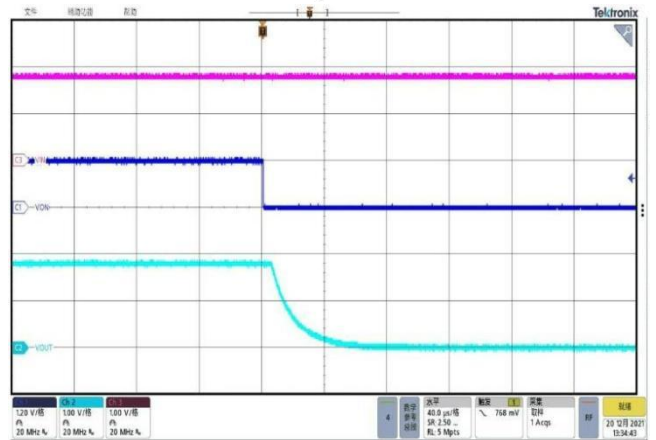

$V_{IN}=1.8V$, $V_{ON}=1.2V$



JXW1512

Typical Performance Characteristics ($C_{IN} = 1\mu F$, $C_{OUT} = 0.1\mu F$, $R_{OUT} = 10\Omega$, $T_A = 25^\circ C$ unless otherwise specified)

V_{ON} ON Response with 10 Ω load

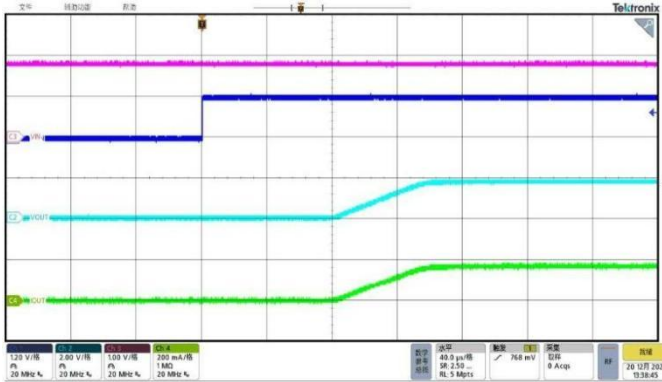

$V_{IN}=1.8V$, $V_{ON}=1.2V$

V_{ON} OFF Response with 10 Ω load

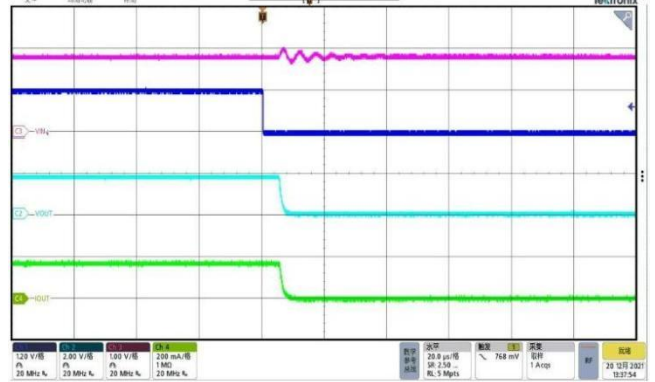

$V_{IN}=1.8V$, $V_{ON}=1.2V$

V_{IN} Power ON w/o load

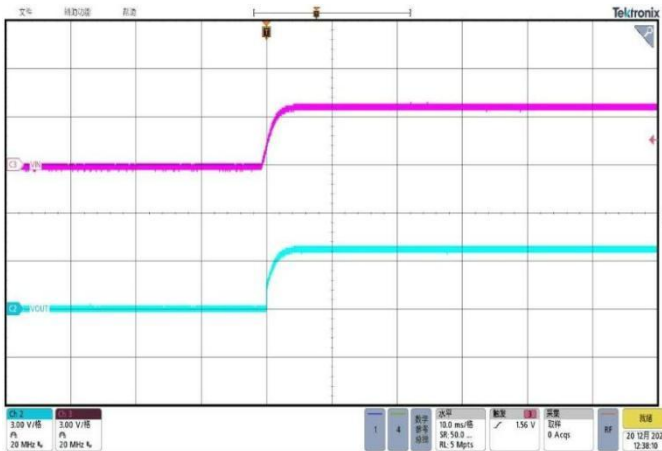

$V_{IN}=V_{ON}=3.7V$

V_{IN} Power OFF w/o load

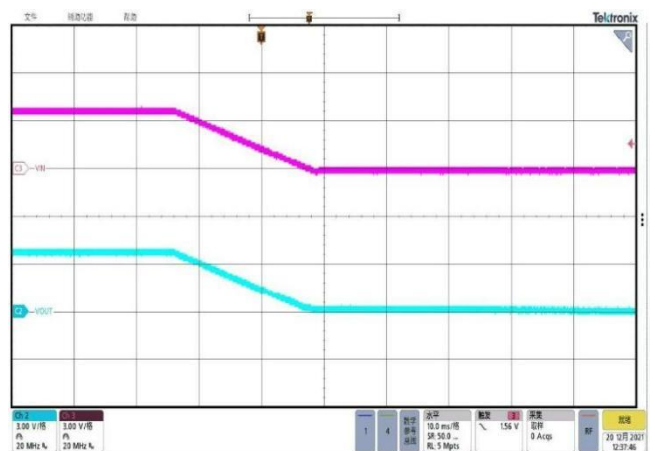

$V_{IN}=V_{ON}=3.7V$

V_{IN} Power ON with 10 Ω load

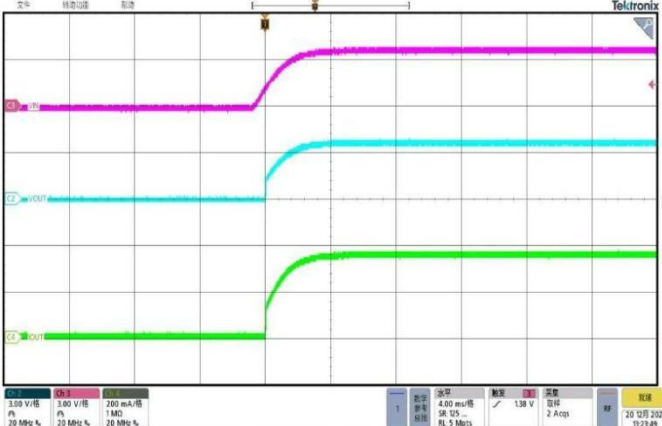

$V_{IN}=V_{ON}=3.7V$

V_{IN} Power OFF with 10 Ω load

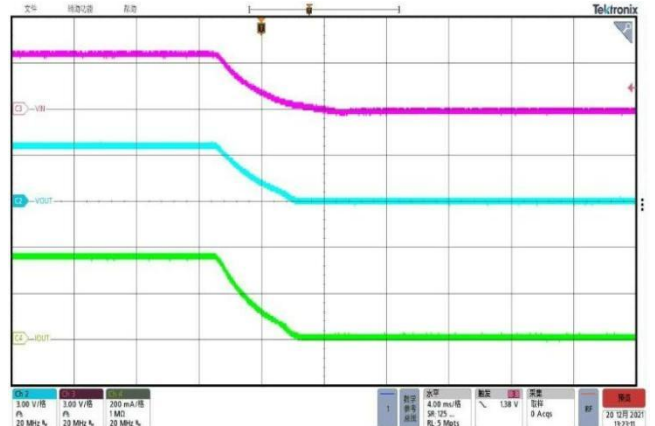

$V_{IN}=V_{ON}=3.7V$



Typical Performance Characteristics ($C_{IN} = 1\mu F$, $C_{OUT} = 0.1\mu F$, $R_{OUT} = 10\Omega$, $T_A = 25^\circ C$ unless otherwise specified)

V_{IN} Power ON w/o load

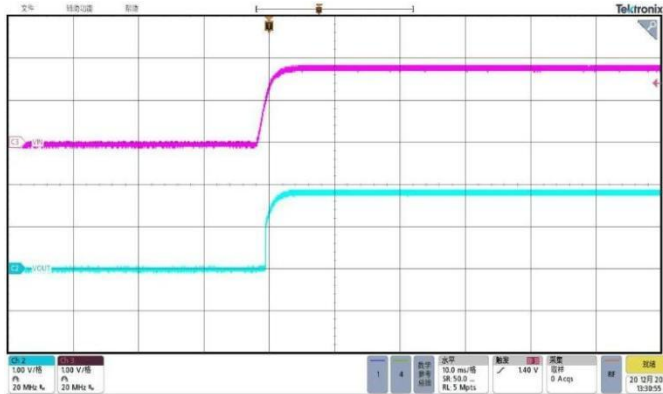

$V_{IN}=V_{ON}=1.8V$

V_{IN} Power OFF w/o load

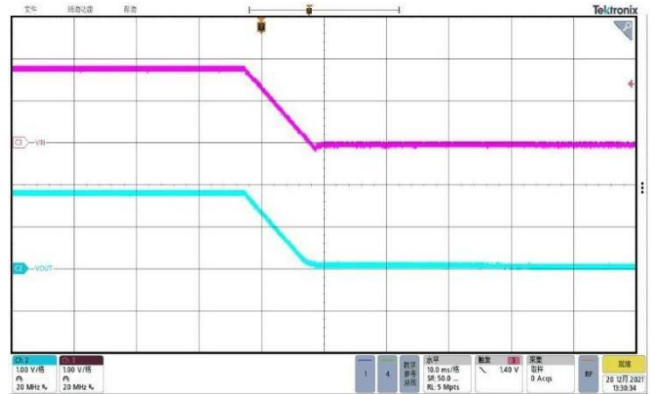

$V_{IN}=V_{ON}=1.8V$

V_{IN} Power ON with 10Ω load

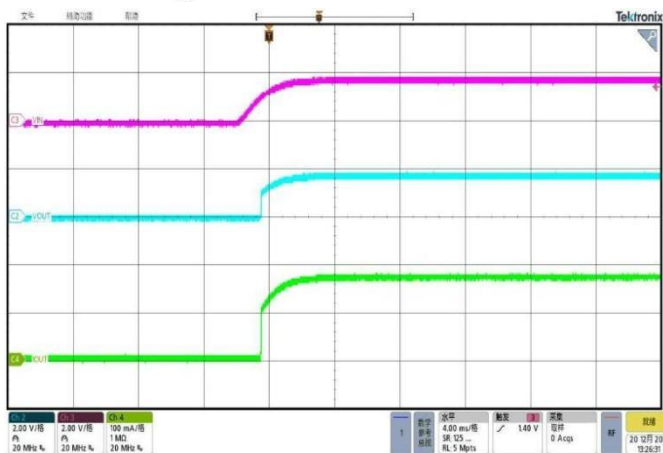

$V_{IN}=V_{ON}=1.8V$

V_{IN} Power OFF with 10Ω load

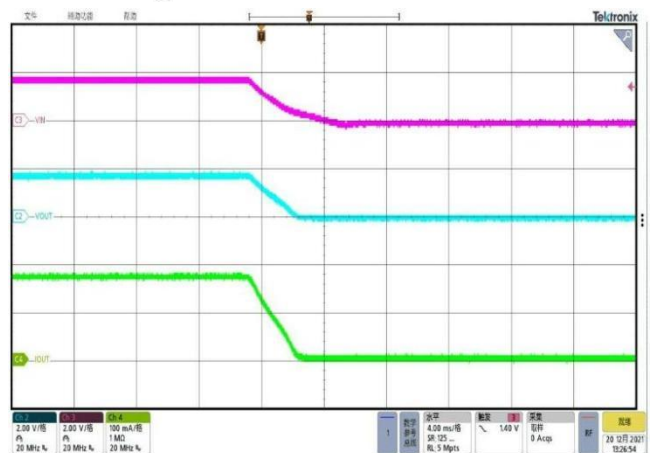

$V_{IN}=V_{ON}=1.8V$

Reverse Protection with 10Ω load

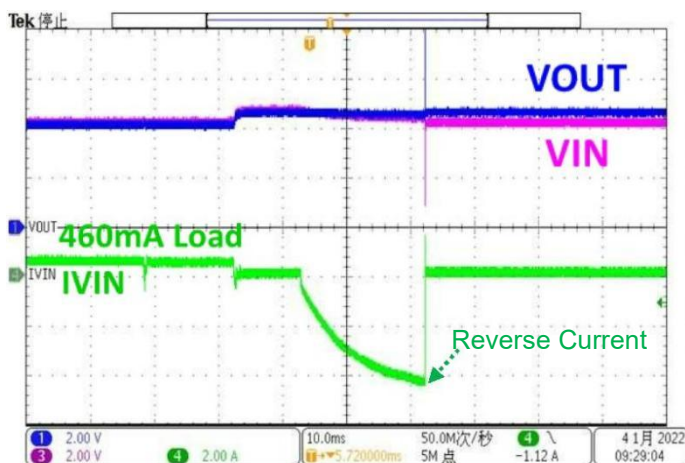

$V_{IN}=V_{ON}=4.2V$

Reverse Protection Recovery with 10Ω load

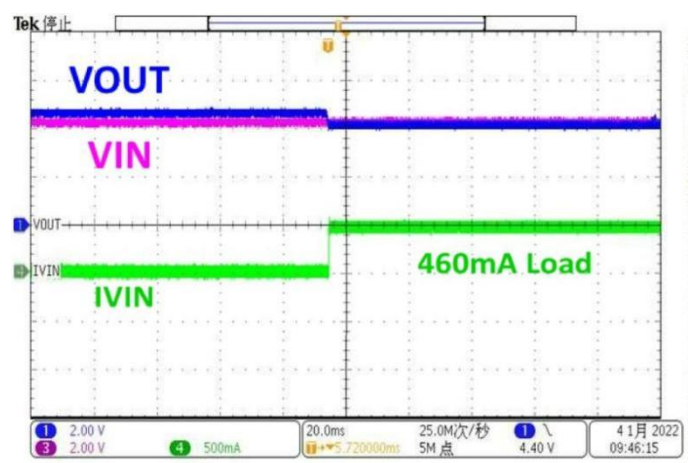

$V_{IN}=V_{ON}=4.2V$



Functional Description

Device Operation

The JXW1512 is a low on-resistance (R_{ON}) load switch with controlled turn on, up to 1.5A output current. It contains a P-channel MOSFET and can be turned on with a wide range application of battery from 1.2V to 5.5V. An on/off input (ON) controls the switch, which can interface with low-threshold 1.2V GPIO control signal. A 130Ω on-chip output resistor is added for output quick discharge when the switch is switched off.

ON/OFF Control

The pin of ON controls the state of the switch. ON is active HI pin and has a low threshold making it capable of interfacing with low voltage GPIO control signals. It can be used with any microcontroller with 1.2V, 1.8V, 2.5V, 3.3V GPIOs. Applying V_{IH} on the ON pin will put the switch in the on-state and V_{IL} will put the switch in the off-state.

ON (Control Input)	VIN to VOUT	Quick Output Discharge Resistance
L	OFF	Yes
H	ON	No

Reverse Current Protection

The device includes a reverse current protection circuit, which stops a reverse current flowing from the VOUT pin to the VIN or GND pin when the voltage on VOUT becomes higher than VIN. This feature is particularly useful when the output of device needs to be driven by another voltage source, whichever device is both disabled and enabled (for example in a power multiplexer application). In order for this feature to work, device has to be disabled, and either of the following conditions shall be met: $V_{IN} > 1.2V$ or $V_{OUT} > 1.2V$. Meanwhile considering of heat dissipation, V_{IN} input voltage should be limited less than 4.8V voltage when V_{ON} is active high.

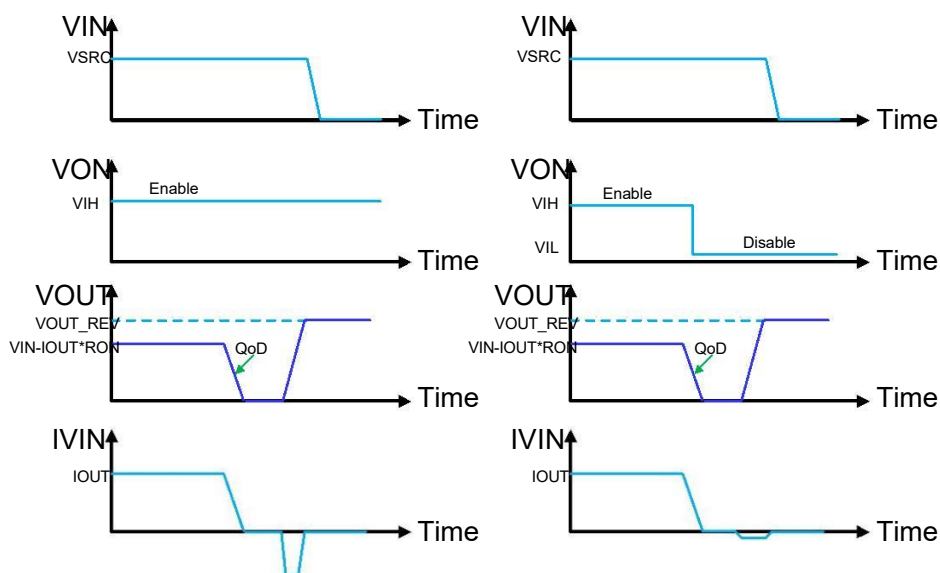

Figure 1

Functional Description (Continued)

Quick Output Discharge

The JXW1512 integrates the quick output discharge (QOD) feature. When the switch is disabled, a discharge resistance with a typical value of 130Ω is connected between the output and ground. This resistance pulls down the output and quickly discharges output capacitor charge, and prevents it from floating when the device is disabled.

Input Bypass Capacitor

A low ESR ceramic capacitor, X5R or X7R, needs to be placed between VIN and GND to limit the voltage drop on the input supply caused by transient in-rush currents. A typical $1\mu\text{F}$ ceramic capacitor, C_{IN} , placed close to the pins is usually needed. C_{IN} 's higher values can be used to further reduce the voltage drop during high current output application. It is recommended that the input capacitor is approximately 10 times higher than the output capacitor to prevent excessive voltage drop when switching heavy loads.

Output Bypass Capacitor

A low ESR ceramic capacitor, X5R or X7R, should be placed between VOUT and GND. A $0.1\mu\text{F}$ ceramic capacitor that is placed close to the IC pins is usually sufficient. This capacitor will prevent parasitic board inductances from forcing VOUT below GND when the switch turns off. It is recommended that C_{IN} is 10times higher than C_{OUT} so that once the switch is turned on, C_{OUT} can be charged up to VIN without VIN dropping significantly.

Power Supply Sequencing without a GPIO Input Control Port

In many terminal devices, each module needs to be powered up in a pre-determined manner. The device can solve the power sequencing problem without increasing any complexity to the overall system. Figure 2 shows the configuration required to power up the two modules in a fixed sequence. The output of the first load switch is tied to the enable of the second load switch, so when load1 is powered, the second load switch is enabled and load2 is powered.

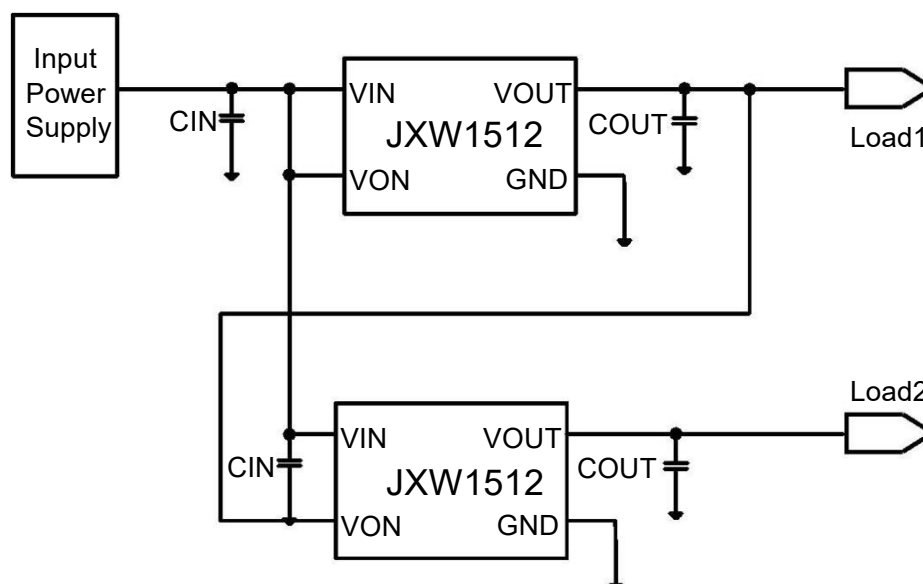
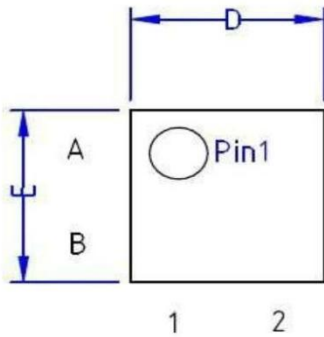
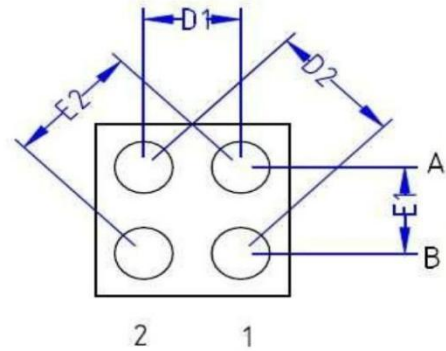

Figure 2

Package Outline Drawing



TOP VIEW
Ball Down



BOTTOM VIEW
Ball Up

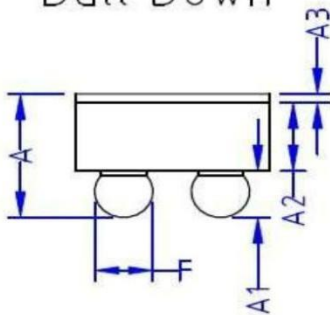

SIDE VIEW OF JXW1512ACST

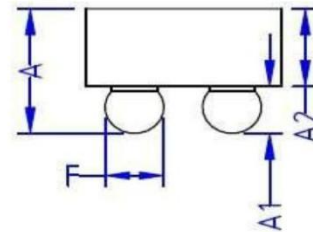

SIDE VIEW OF JXW1512ACPT

Unit:mm			
	NO.	Mean	Tolerance
Top Thickness	A	0.449	±0.036
Ball Height+UBM Thickness	A1	0.194	±0.023
Wafer/Grinding Thickness	A2	0.215	±0.0125
Backside Coating Thickness	A3	0.04	±0.005
Pkg Die Size	X	D	0.775 ±0.025
	Y	E	0.775 ±0.025
Ball Size afer reflow	F	0.268	±0.020
Ball Pitch	D1	0.4	NA
	D2	0.565	NA
	E1	0.4	NA
	E2	0.565	NA

Unit:mm			
	NO.	Mean	Tolerance
Top Thickness	A	0.449	±0.0355
Ball Height+UBM Thickness	A1	0.194	±0.023
Wafer/Grinding Thickness	A2	0.255	±0.0125
Pkg Die Size	X	D	0.775 ±0.025
	Y	E	0.775 ±0.025
Ball Size afer reflow	F	0.268	±0.020
Ball Pitch	D1	0.4	NA
	D2	0.565	NA
	E1	0.4	NA
	E2	0.565	NA